

Surface Area & Volume Practice

Name: _____

Find surface area & volume: (Feel free to do work on a separate sheet of paper)
Keep your work organized. You can use a calc.

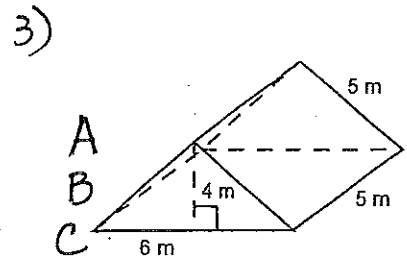

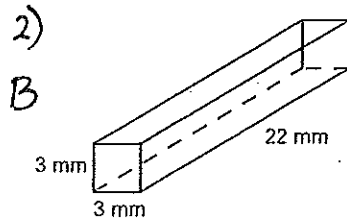
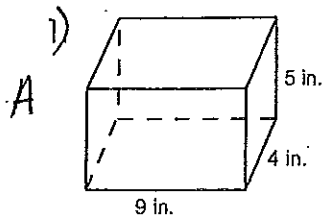
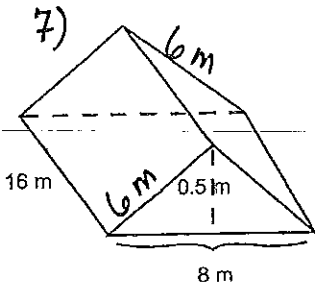
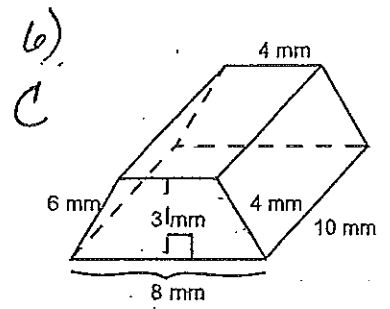
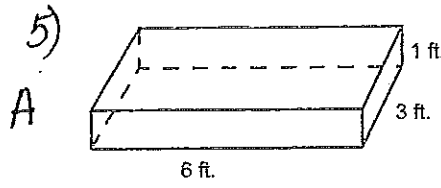
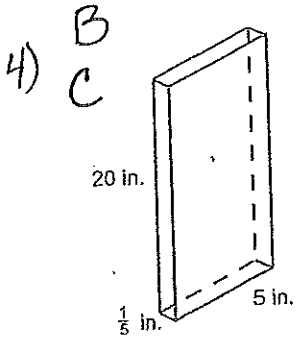

Surface Area only

G
I
V
E
I
T
A
T
R
Y.

