

What Happens When the Smog Lifts in Los Angeles, California?

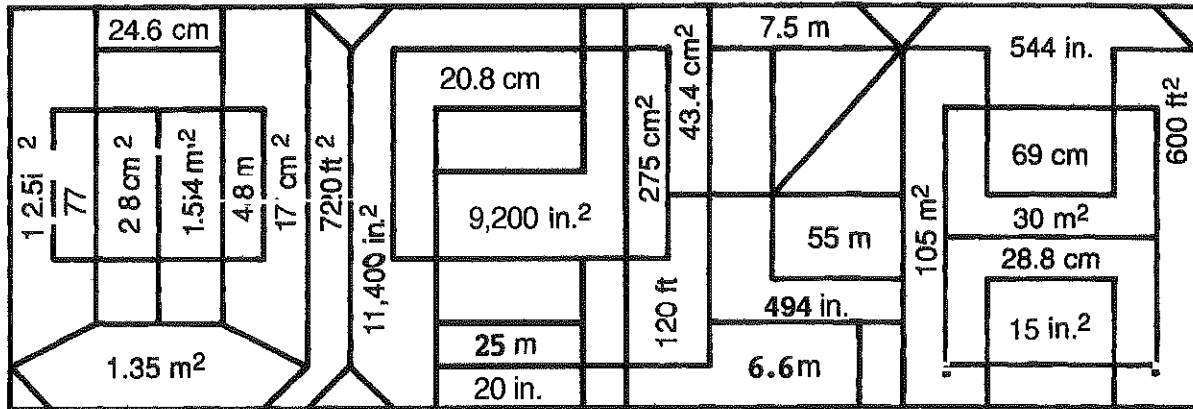

Find the AREA and the PERIMETER of each triangle below. Look for both answers in the rectangle. Shade in each area containing a correct answer.

①

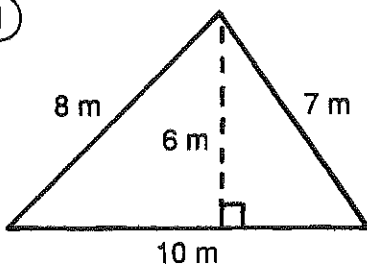

②

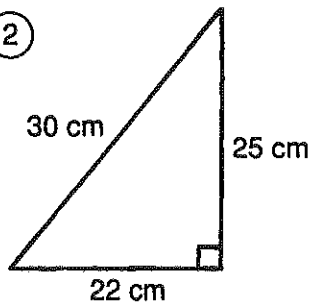

③

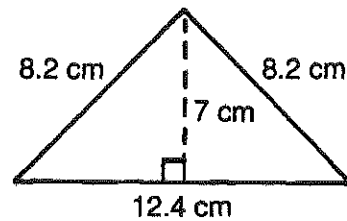

④

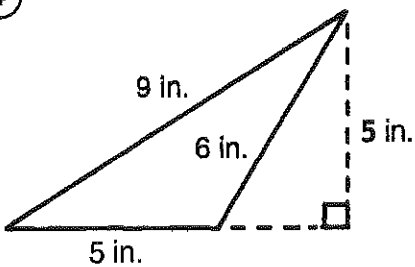

⑤

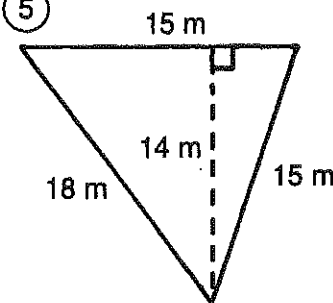

⑥

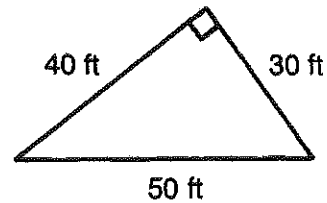

⑦

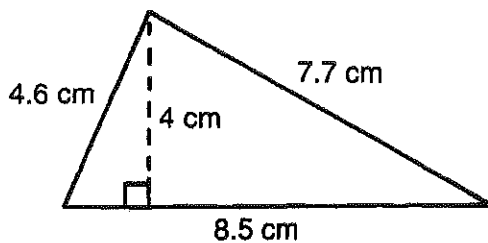

⑧

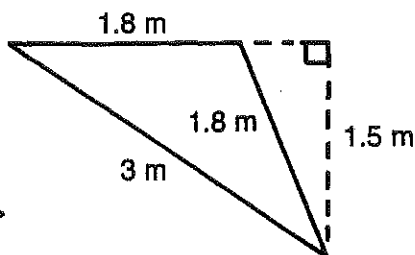

⑨

