

Name : _____

Score : _____

Teacher : _____

Date : _____

Find the missing angle measurement in each set of complementary angles.

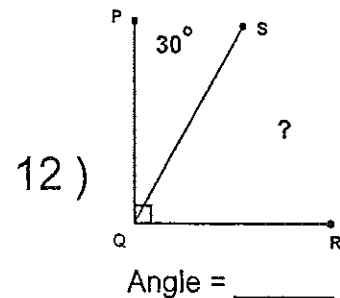
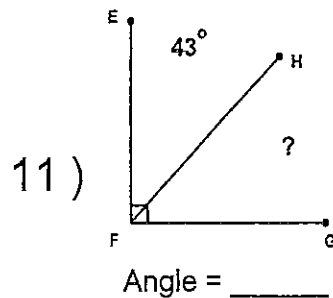
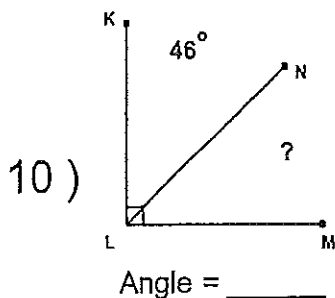
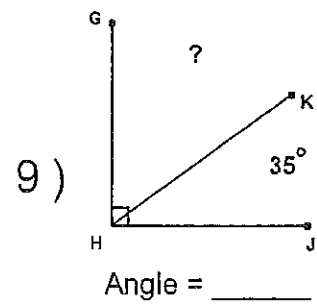
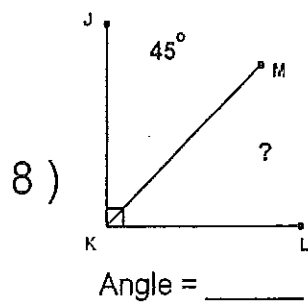
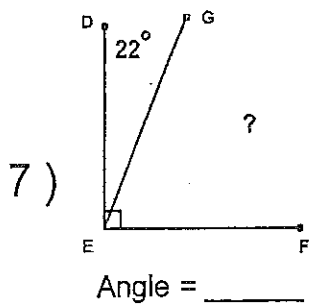
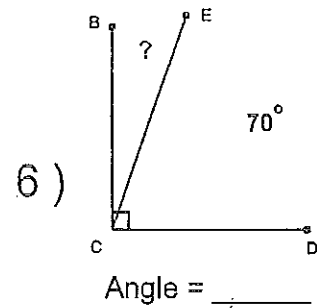
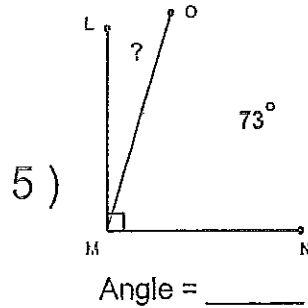
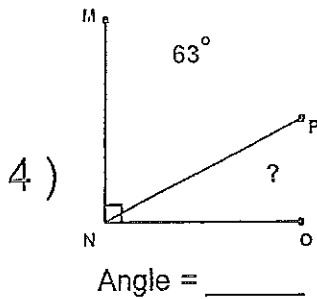
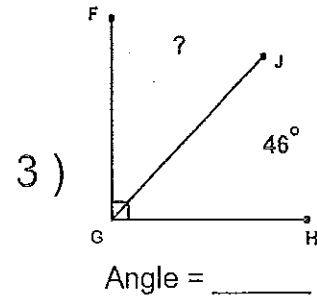
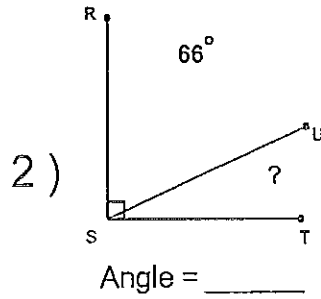
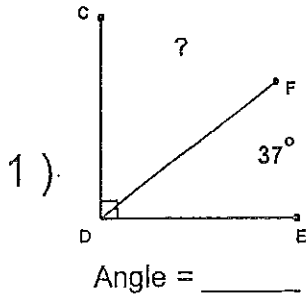

Name : _____

Score : _____

Teacher : _____

Date : _____

Find the missing angle measurement in each set of supplementary angles.

1)

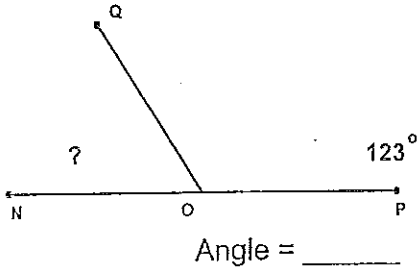

2)

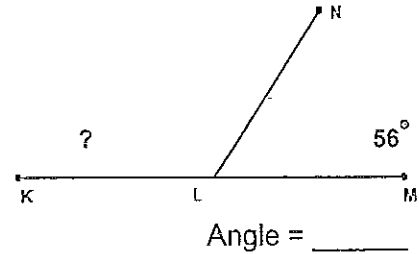

3)

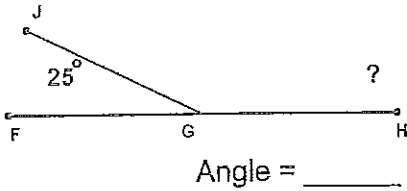

4)

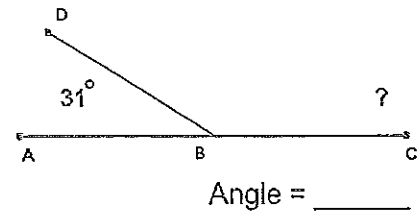

5)

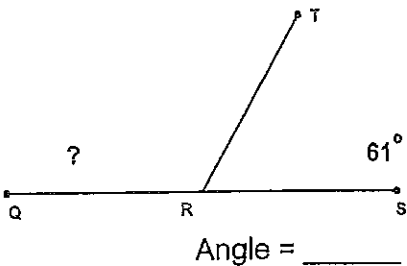

6)

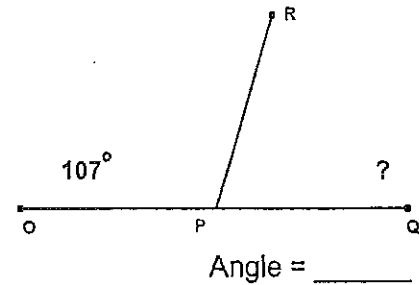

7)

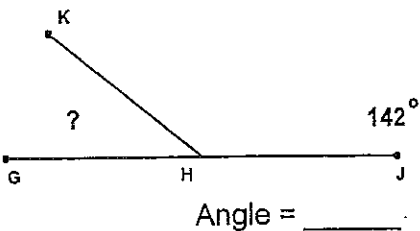

8)

