

Quadrilaterals

Name _____

Find the perimeter & area. Show all the formulas & all of your work.
Name each polygon.

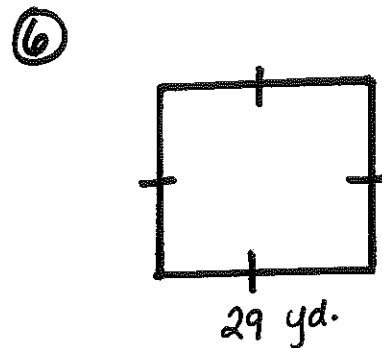
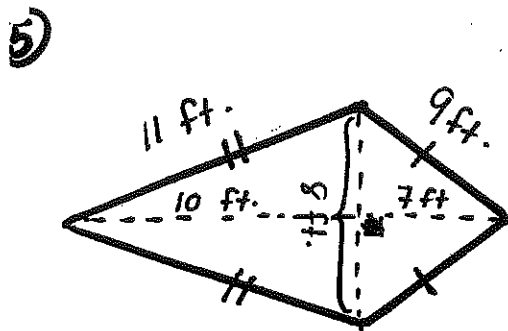
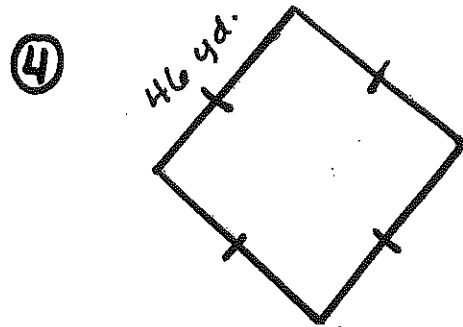
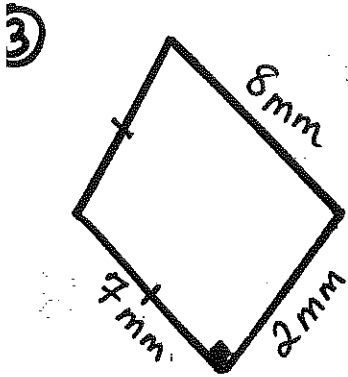
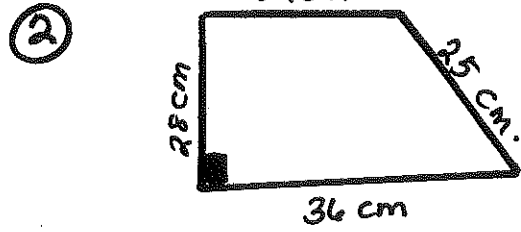
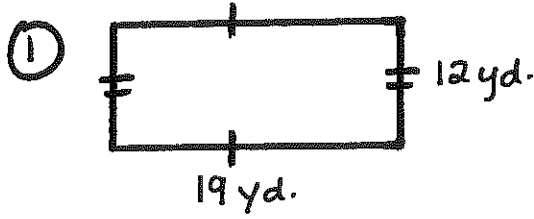

7

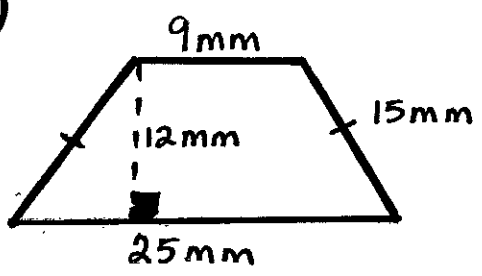

8

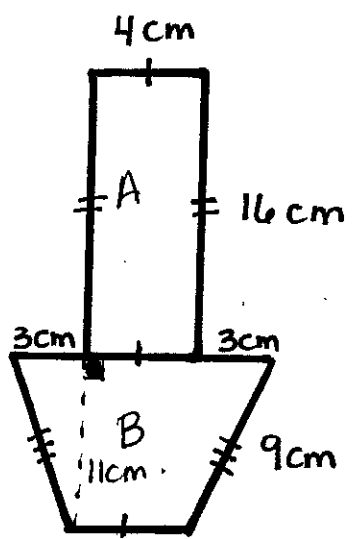
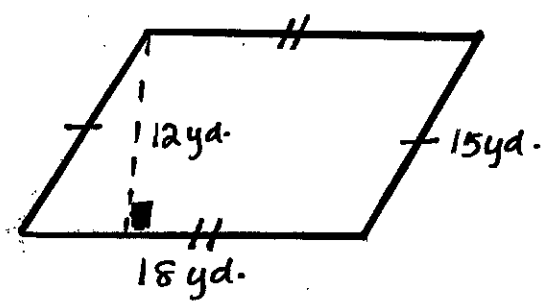

$$P = 4 + 16 + 3 + 9 + 4 + 9 + 3 + 16 = \boxed{64 \text{ cm}}$$

10

