

Tier A: 2, 4, 5, 6, 11
 Tier B: 2, 4, 6, 11, 18
 Tier C: 2, 4, 6, 7, 13

FANTASTIC FORMULAS PRACTICE

Determine the perimeter and area of each figure. Show the formula you use and all of your work. You may use a calculator.

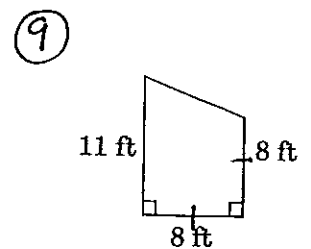
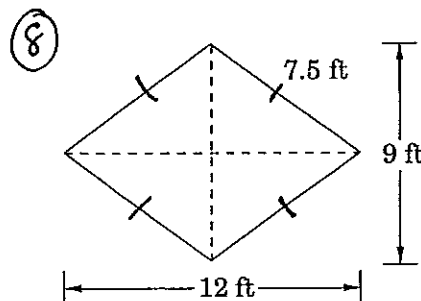
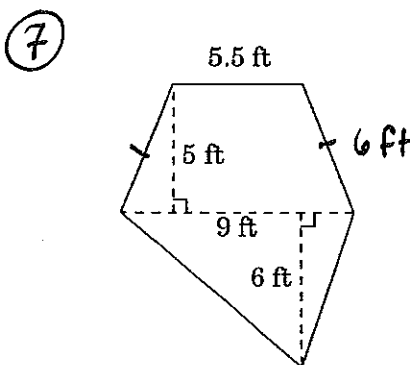
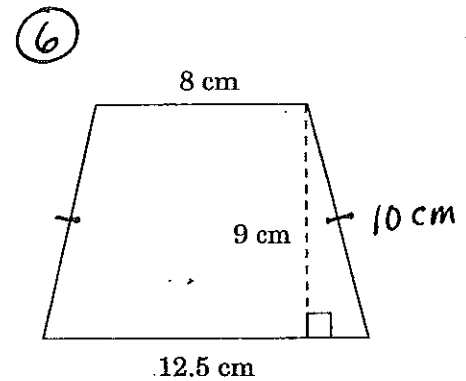
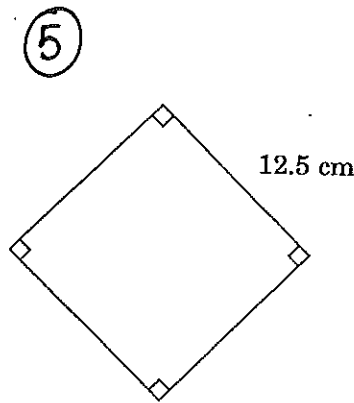
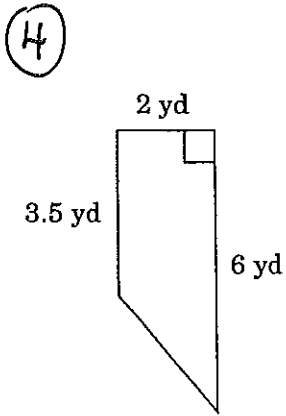
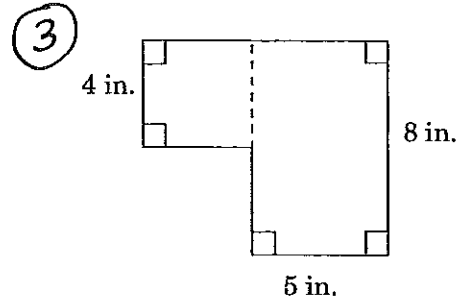
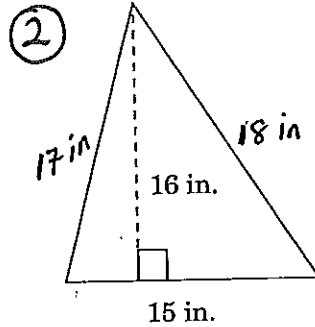
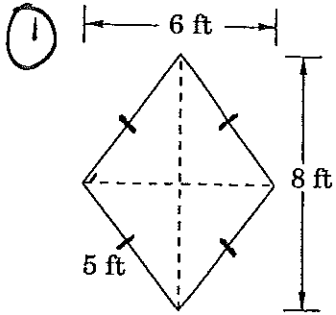

10

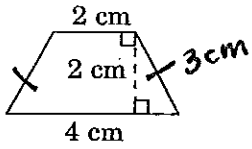

11

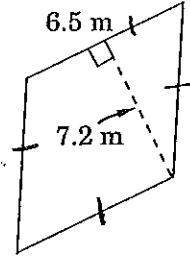

12

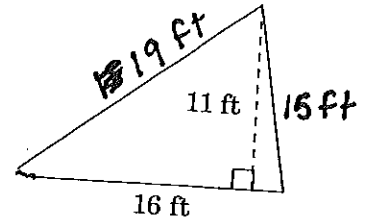

13

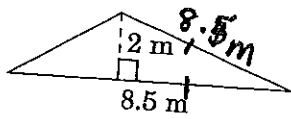

14

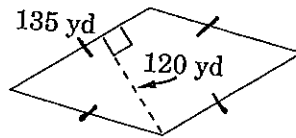

15

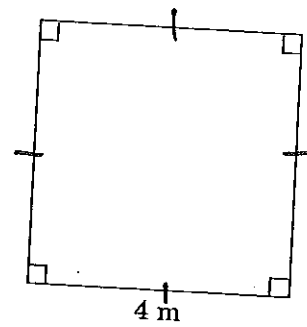

16

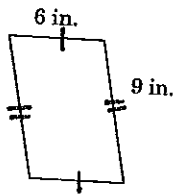

17

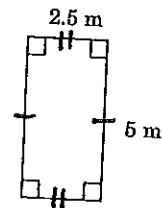

18

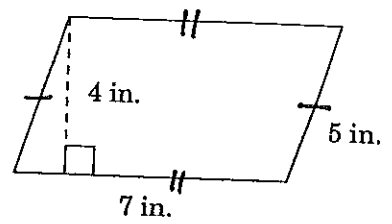

19

